

BIJGEBOUWEN

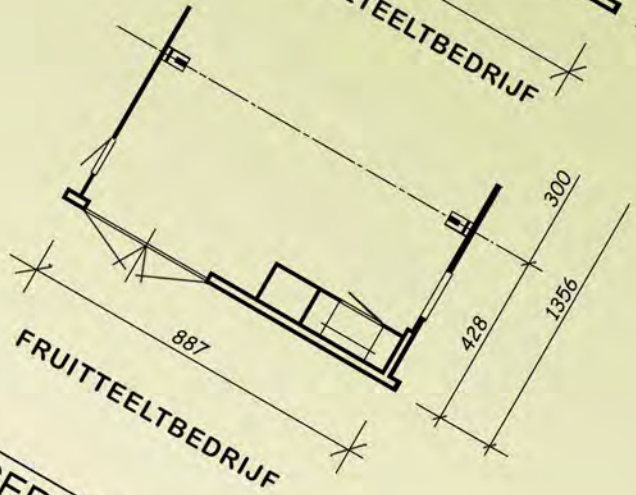
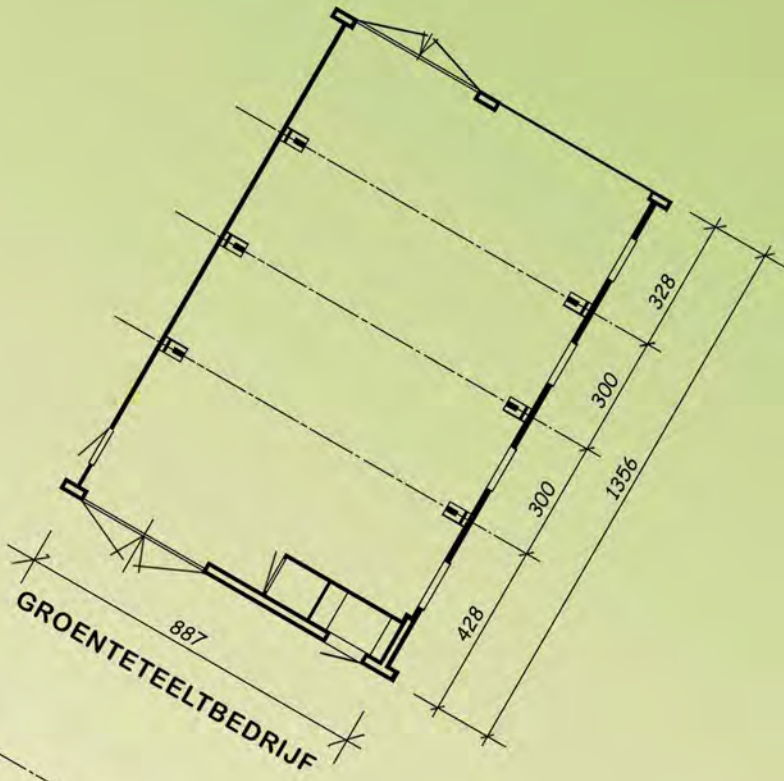
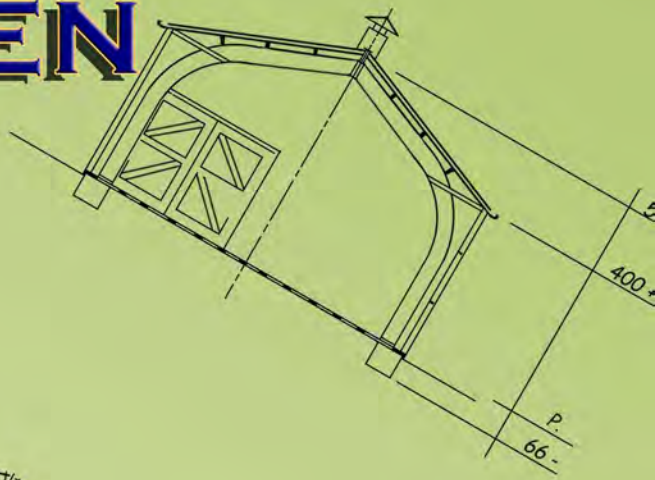

AN DE WIERINGERMEER (NOORDOOSTPOLDERWERKEN)	
BETREFT: GROENTE EN FRUITTEELTBEDRIJVEN	
BEDRIJFSSCHUUR TYPE P	
ARCH.	FORM.
STAMBOEK No.	

OPP. 120 m²
INH. 615 m³

Droogmakerij & Polderhistorie
Kees Bolle - historisch verteller

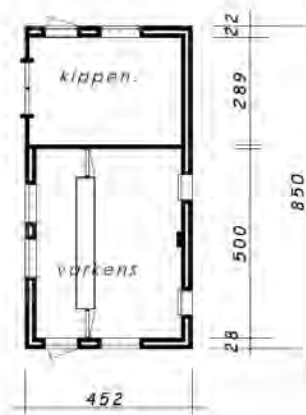
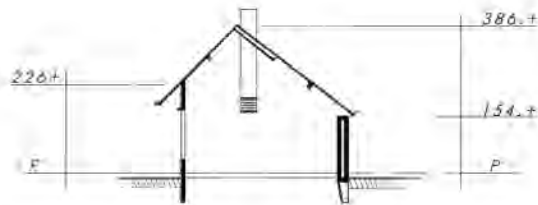

OPP 38 m³
 INH 126 m³

DIRECTIE VAN DE WIERINGERMEER (NOORDOOSTPOLDERWERKEN)										
BOUWKUNDIGE AFD.	DATUM:	12. 1. '51	BETREFT.							
	GETEK.	<i>Jeursen.</i>	BIJGEBOUWEN							
	GECONTR.	<i>X</i>	BIJGSCHUUR VOOR VARKENS EN KIPPEN							
BOERDERJENBOUW	GEZIEN.	<i>M.</i>					ARCH.	FORM.	STAMBOEK No.	Ex.
	SCHAAL.	1:200						A ¹	9472	

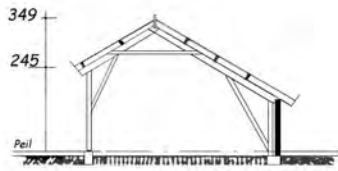

Doorsn. wagenberging

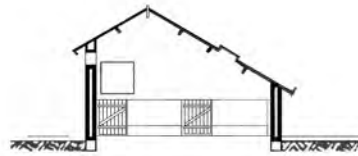

Doorsn. varkenshok

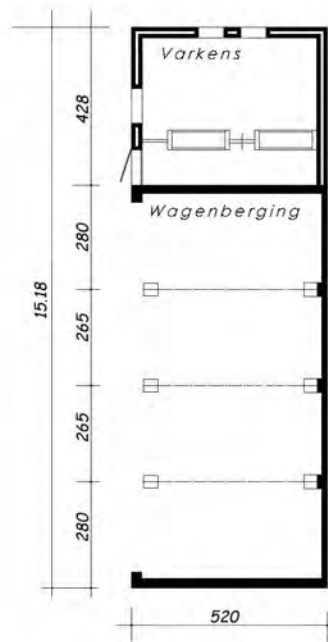
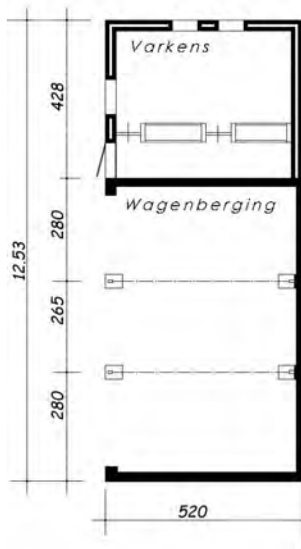

OPP 66 m²
INH 208 m³

OPP 80 m²
INH 252 m³

DIRECTIE VAN DE WIERINGERMEER (NOORDOOSTPOLDERWERKEN)

BOUWKUNDIGE AFD.

DATUM:	18.2 '51
GETEK.	<i>[Handwritten signature]</i>
GECONTR.	<i>[Handwritten signature]</i>
GEZIEN.	<i>[Handwritten signature]</i>

BETREFT.
BIJGEBOUWEN
BIJSCHUUR BIJ BOERDERIJ TYPE C⁴ C⁵

BOERDERIJENBOUW

SCHAAL. 1:200

ARCH.	FORM.	STAMBOEK No.	Ex.
	A ¹	9476	

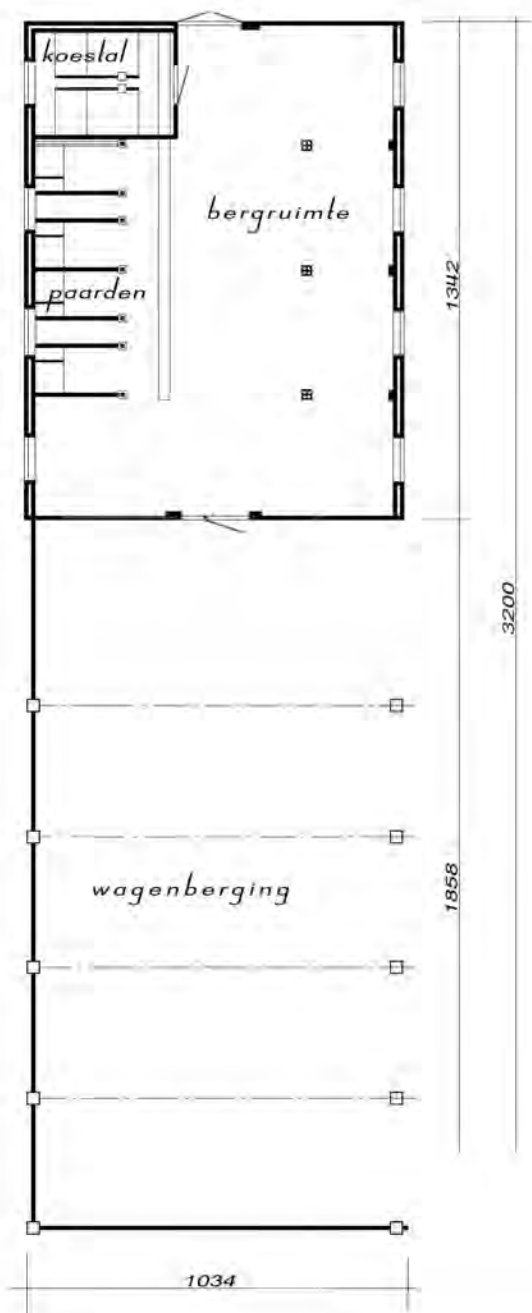
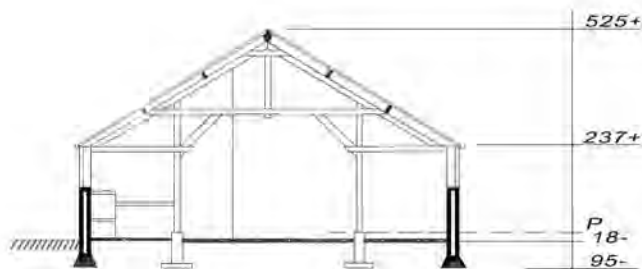

OPP. 330 m²
INH. 1320 m³

DIRECTIE VAN DE WIERINGERMEER (NOORDOOSTPOLDERWERKEN)

BOUWKUNDIGE AFD.	DATUM:	2.1 '51	BETREFT. BIJGEBOUWEN BIJSCHUUR TYPE C			
	GETEK.	<i>Jeursen.</i>				
	GECONTR.	<i>[Signature]</i>				
BOERDERJENBOUW	GEZIEN.	<i>[Signature]</i>	ARCH.	FORM.	STAMBOEK No.	Ex.
	SCHAAL.	1:200		A ¹	9462	

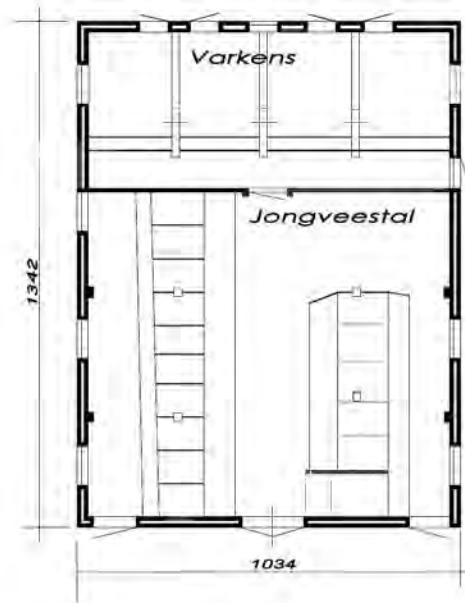
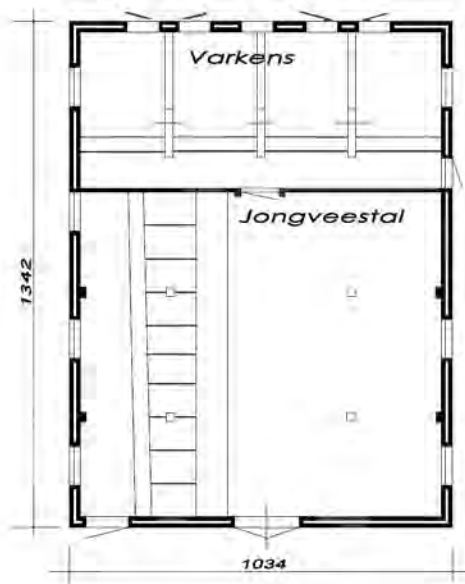
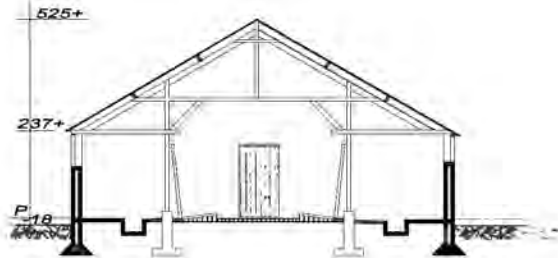
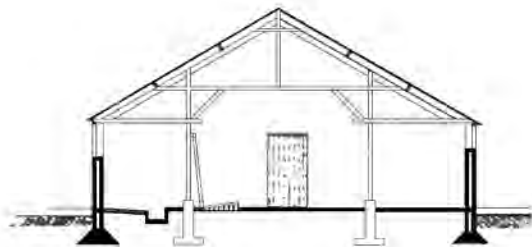

OPP 139 m
 OPP 139 m²
 INH 554 m³

DIRECTIE VAN DE WIERINGERMEER (NOORDOOSTPOLDERWERKEN)						
BOUWKUNDIGE AFD.	DATUM:	2.1 '51	BETREFT.			
	GETEK.	<i>W. Z. X.</i>	BIJGEBOUWEN			
	GECONTR.	<i>K.</i>	BIJSCHUUR TYPE C.			
BOERDERIJENBOUW	GEZIEN.	<i>M.</i>	ARCH.	FORM.	STAMBOEK No.	Ex.
	SCHAAL.	1:200		A ¹	9464	

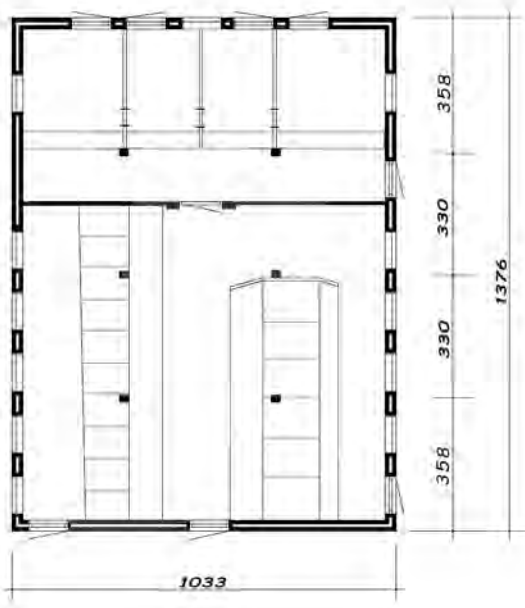

OPP 142 m²
 INH 585 m³

DIRECTIE VAN DE WIERINGERMEER (NOORDOOSTPOLDERWERKEN)						
BOUWKUNDIGE AFD.	DATUM:	21.8.'57	BETREFT. BIJGEBOUWEN BIJSCHUUR TYPE. E			
	GETEK.	<i>Jeursen.</i>				
	GECONTR.	<i>[Signature]</i>				
BOERDERJENBOUW	GEZIEN.	<i>[Signature]</i>	ARCH.	FORM.	STAMBOEK No.	Ex.
	SCHAAL.	1:200		A ¹	9470	

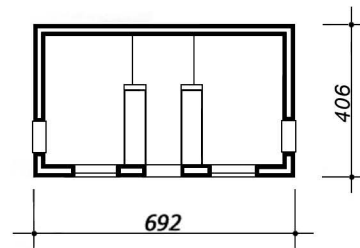
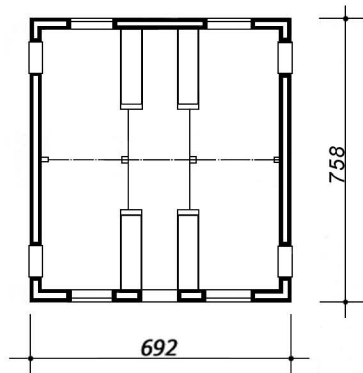
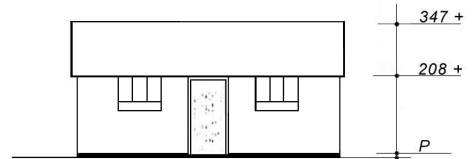
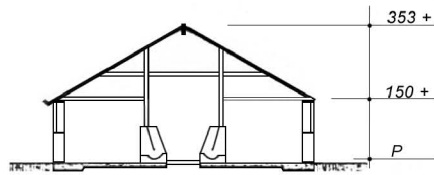

OPP 52 m²
INH 143 m³

OPP 28 m²
INH 82 m³

DIRECTIE VAN DE WIERINGERMEER (NOORDOOSTPOLDERWERKEN)

BOUWKUNDIGE AFD.

DATUM:	12.1 '51
GETEK.	Jeurson.
GECONTR.	<i>[Signature]</i>
GEZIEN.	<i>[Signature]</i>

BETREFT.
BIJGEBOUWEN
VARKENSS TAL TYPE. F.

BOERDERJENBOUW

SCHAAL. 1:200

ARCH.

FORM.

A¹

STAMBOEK No.

9471

Ex.

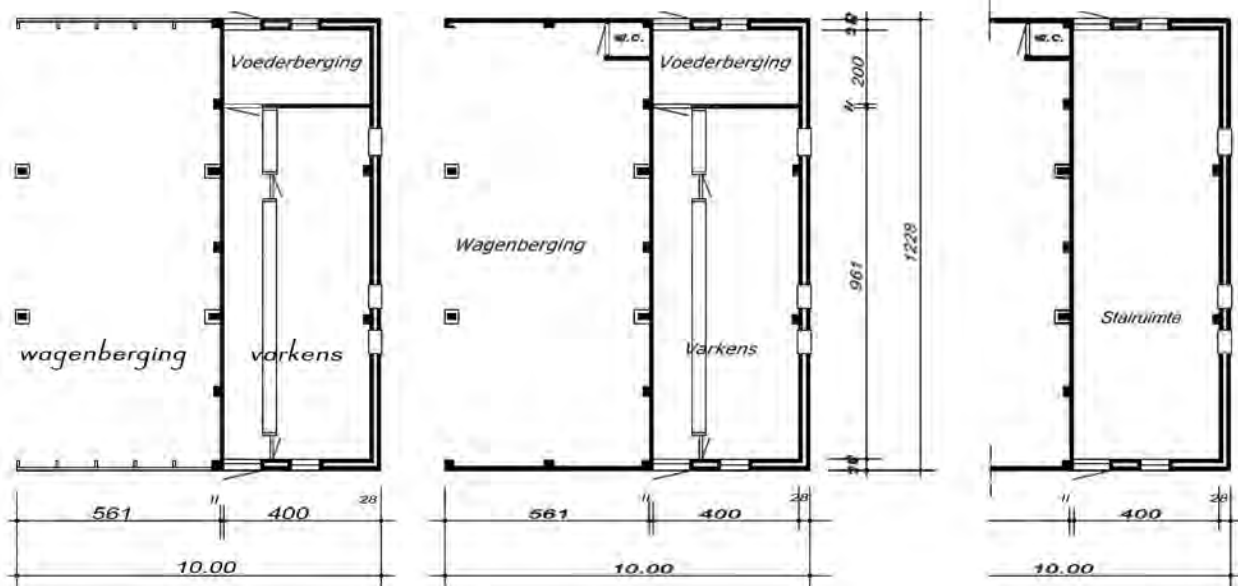
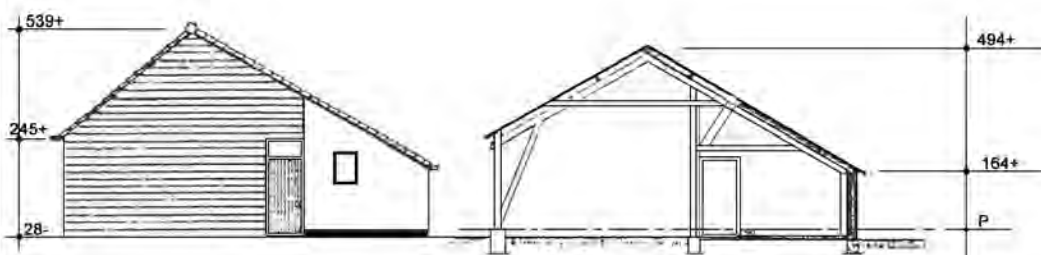

OPP 122 m²
 INH 481 m³

DIRECTIE VAN DE WIERINGERMEER (NOORDOOSTPOLDERWERKEN)

BOUWKUNDIGE AFD.

DATUM: 19-1 '51
 GETEK. *Jeunson.*
 GECONTR. *[Signature]*
 GEZIEN. *[Signature]*

BETREFT.
 BIJGEBOUWEN
 BIJSCHUUR TYPE **G3**

BOERDERIJENBOUW

SCHAAL. 1:200

ARCH.	FORM. A ¹	STAMBOEK No. 9477	Ex.
-------	----------------------	-------------------	-----

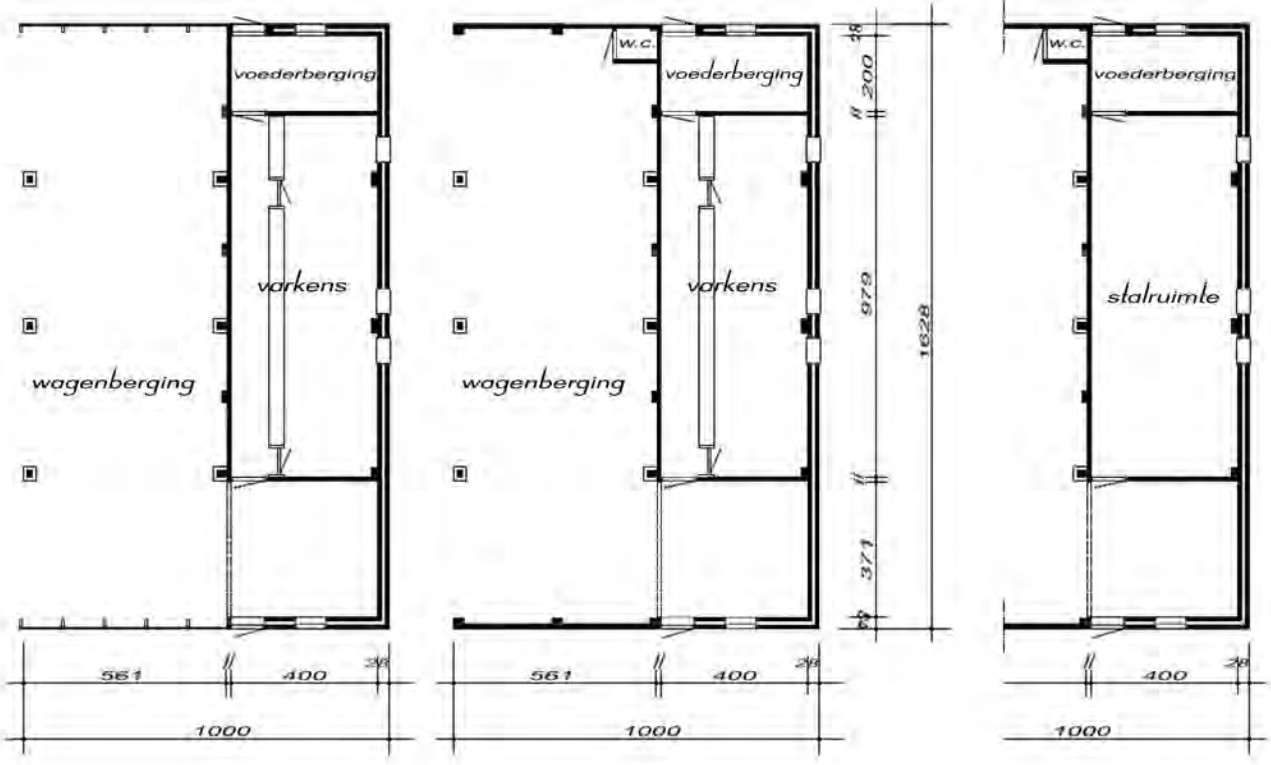
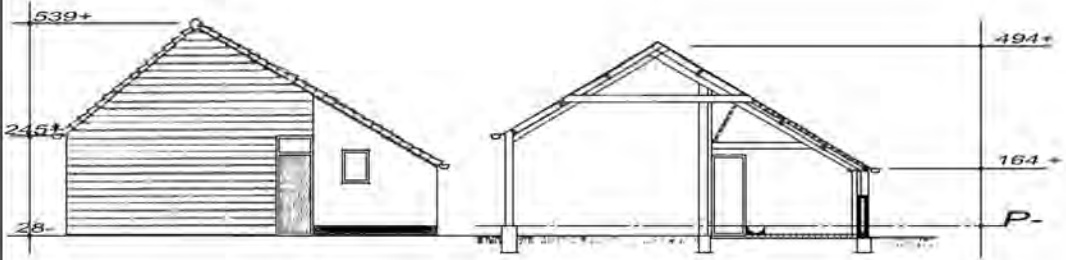

OPP 162 m²
 INH 638 m³

DIRECTIE VAN DE WIERINGERMEER (NOORDOOSTPOLDERWERKEN)					
BOUWKUNDIGE AFD.	DATUM:	5.1 '51	BETREFT.		
	GETEK.	<i>Jeursen.</i>	BIJGEBOUWEN		
BOERDERIJENBOUW	GECONTR.	<i>[Signature]</i>	BIJSCHUUR TYPE G ⁴		
	GEZIEN.	<i>[Signature]</i>	ARCH.	FORM.	STAMBOEK No.
	SCHAAL.	1:200		A ¹	9478
					Ex.

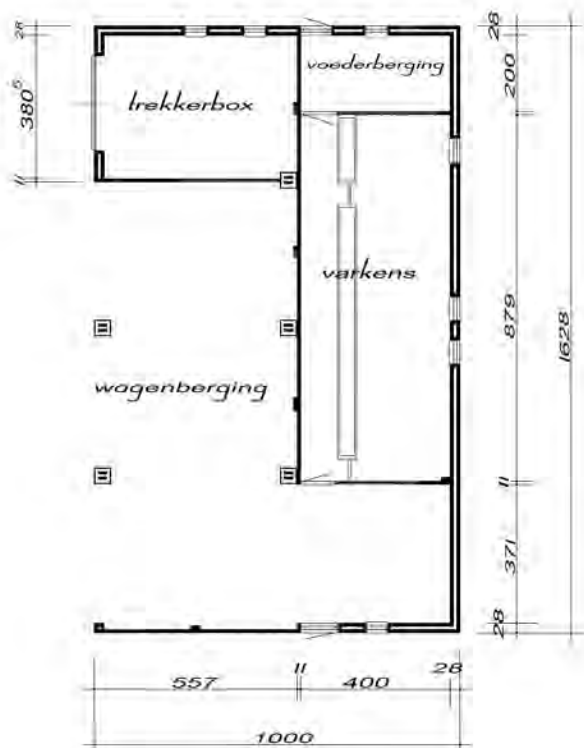

OPP 163 m²
INH 638 m³

DIRECTIE VAN DE WIERINGERMEER (NOORDOOSTPOLDERWERKEN)						
BOUWKUNDIGE AFD.	DATUM:	21-8-'57	BETREFT.			
	GETEK.	Jeursen.	BIJGEBOUWEN			
	GECONTR.	<i>[Signature]</i>	BIJSCHUUR TYPE G ⁴ var.			
BOERDERJENBOUW	GEZIEN.	<i>[Signature]</i>	ARCH.	FORM.	STAMBOEK No.	Ex.
	SCHAAL:	1:200		A ¹	55166	

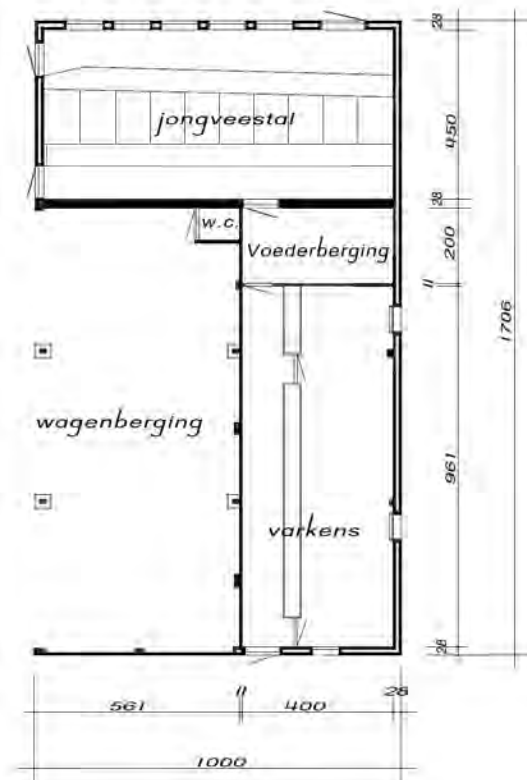
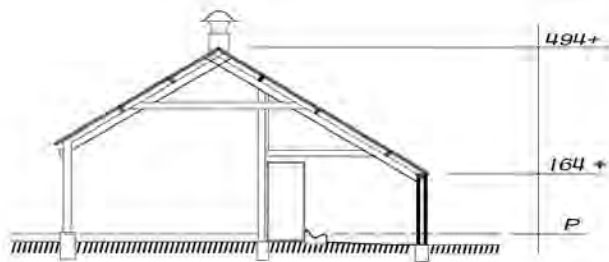

OPP 171 m²
 INH 689 m³

DIRECTIE VAN DE WIERINGERMEER (NOORDOOSTPOLDERWERKEN)

BOUWKUNDIGE AFD.	DATUM:	2.1 '51	BETREFT. BIJGEBOUWEN BIJSCHUUR TYPE C.			
	GETEK.	<i>W. Z. Z. A.</i>				
	GECONTR.	<i>[Signature]</i>				
BOERDERIJENBOUW	GEZIEN.	<i>[Signature]</i>	ARCH.	FORM.	STAMBOEK No.	Ex.
	SCHAAL.	1:200		A ¹	9464	

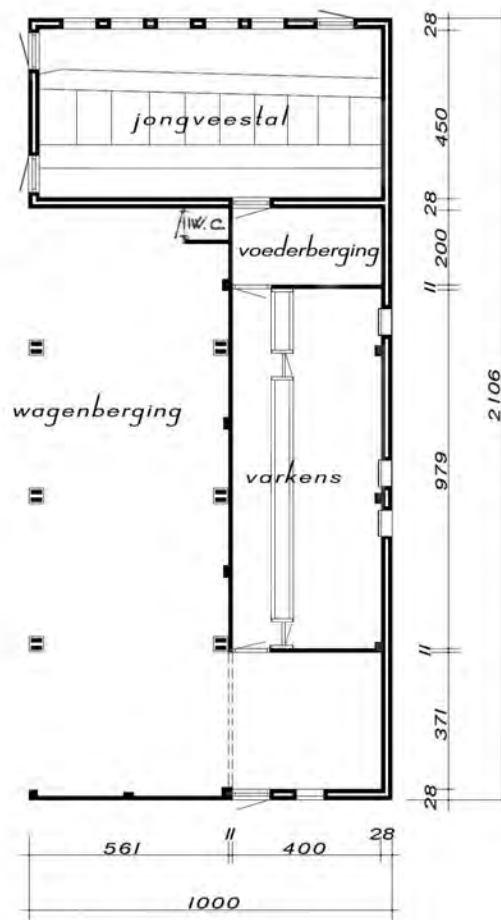
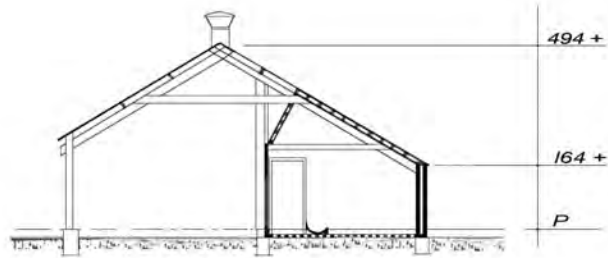

OPP 211 m²
INH 826 m³

DIRECTIE VAN DE WIERINGERMEER (NOORDOOSTPOLDERWERKEN)

BOUWKUNDIGE AFD.	DATUM:	8. 12. '55	BETREFT.			
	GETEK.	<i>Jeursen.</i>	BIJGEBOUWEN 5 b			
	GECONTR.	<i>[Signature]</i>	BIJSCHUUR G			
BOERDERJENBOUW	GEZIEN.	<i>[Signature]</i>	ARCH.	FORM.	STAMBOEK No.	Ex.
	SCHAAL.	1:200		A ¹	49904	

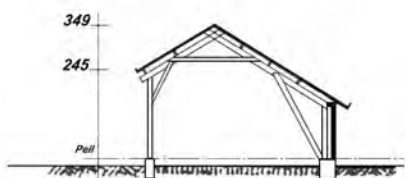

Doorsn: Wagenberging

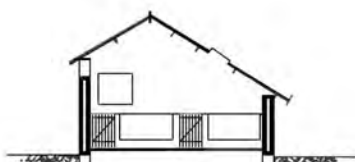

Doorsn: Varkens



L. Zijgevel.

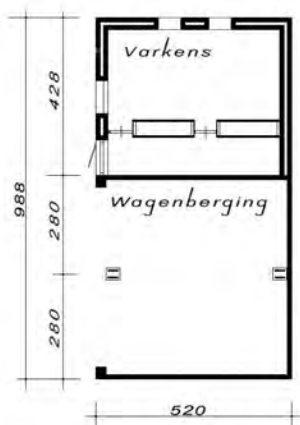

OPP 52 m²
INH 164 m³

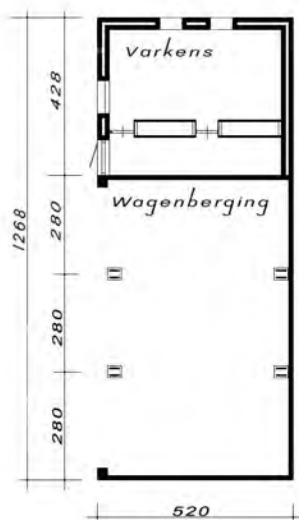

OPP 66 m²
INH 208 m³

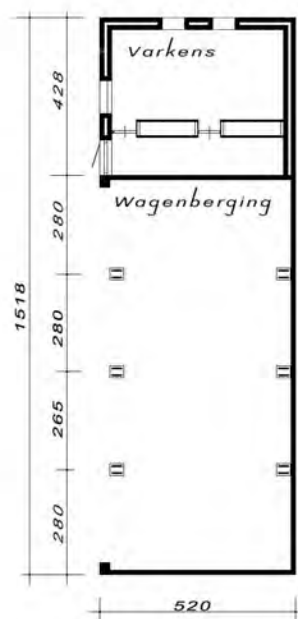

OPP 80 m²
INH 252 m³

DIRECTIE VAN DE WIERINGERMEER (NOORDOOSTPOLDERWERKEN)

BOUWKUNDIGE AFD.

DATUM: 12. 1. '51
GETEK. W. Z. X.
GECONTR.
GEZIEN.

BETREFT.

BIJGEBOUWEN
BIJSCHUUR TYPE H.² H.³ H.⁴

BOERDERIJENBOUW

SCHAAL. 1:200

ARCH. FORM. STAMBOEK No.
A¹ 49827

Ex.

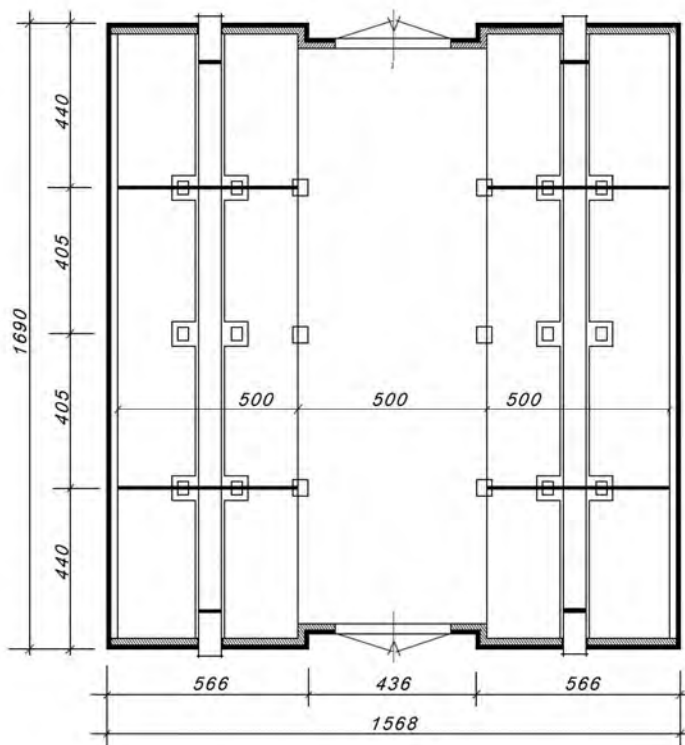
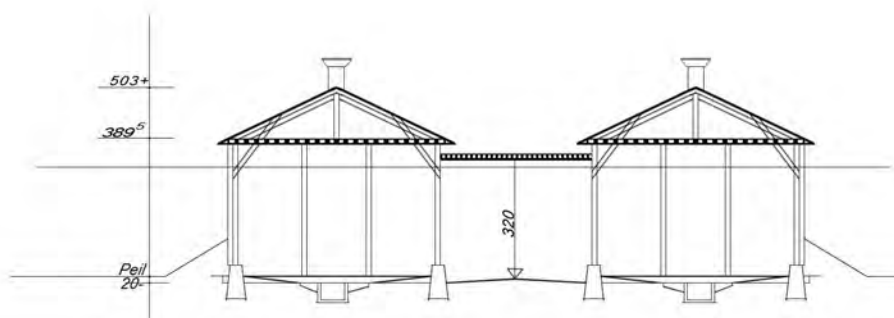

zie ook kavel T. 112

OPP 265 m²

INH 1106 m³

DIRECTIE VAN DE WIERINGERMEER (NOORDOOSTPOLDERWERKEN)					
BOUWKUNDIGE AFD.	DATUM:	11. 11. '55.	BETREFT.		
	GETEK.	<i>[Handwritten Signature]</i>	BIJGEBOUWEN		
	GECONTR.	<i>[Handwritten Signature]</i>	AARDAPPELBEWAARPLAATS TYPE J		
BOERDERIJENBOUW	GEZIEN.	<i>[Handwritten Signature]</i>	ARCH.	FORM.	STAMBOEK No.
	SCHAAL.	1:200		A ¹	49839
					Ex.

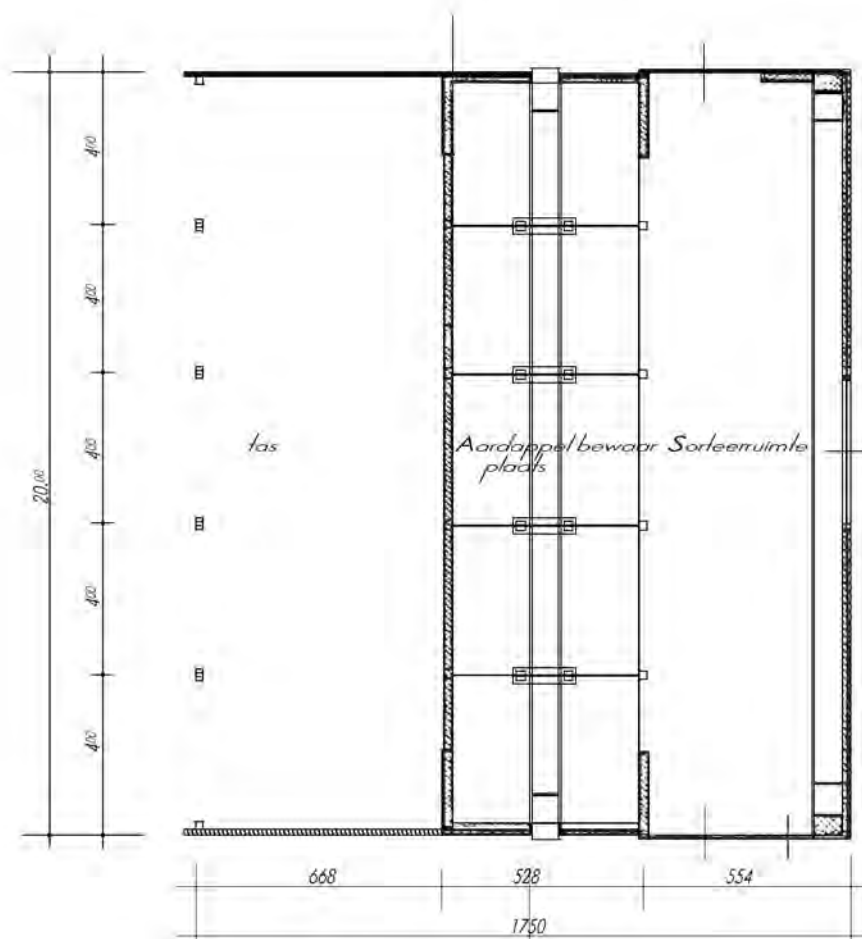
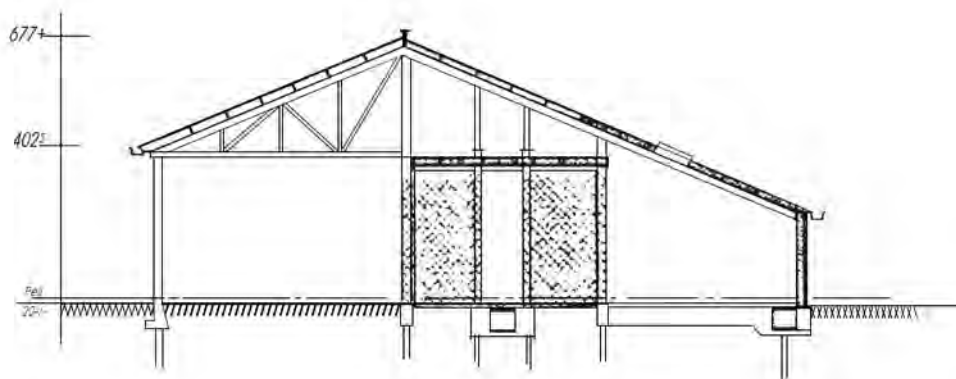

OPP 350 m²

INH 1887 m²

DIRECTIE VAN DE WIERINGERMEER (NOORDOOSTPOLDERWERKEN)

BOUWKUNDIGE AFD.

DATUM:	10.11.'55
GETEK.	<i>W. Z. X.</i>
GECONTR.	<i>X</i>
GEZIEN.	<i>M.</i>

BETREFT.
BUIGBOUWEN
KAPSCHUUR - AARDAPPELBEW.PL.TYPE K

BOERDERIJENBOUW

SCHAAL. 1:200

ARCH.	FORM.	STAMBOEK No.	Ex.
	A ¹	49837	

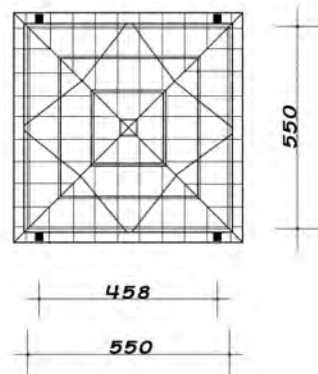
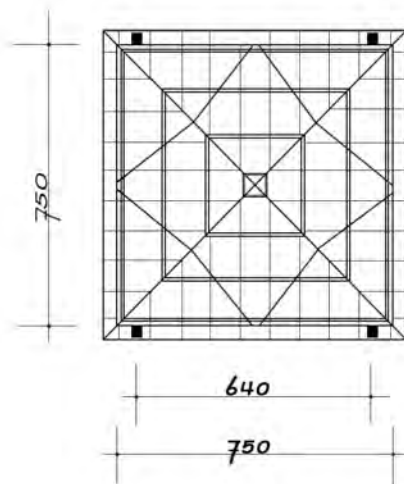
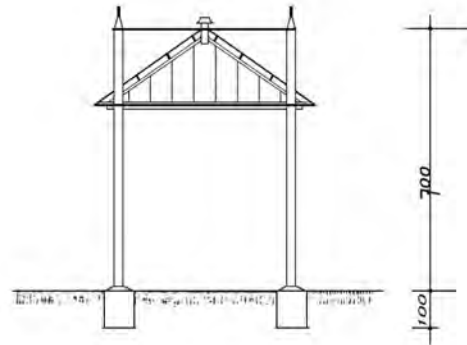
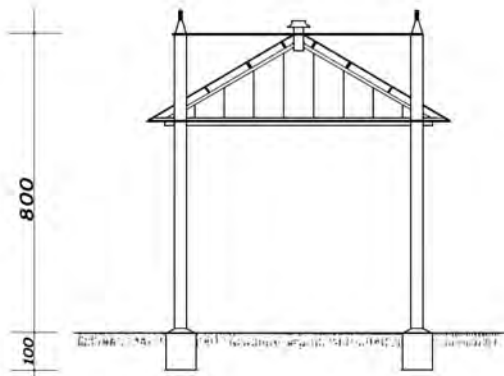

DIRECTIE VAN DE WIERINGERMEER (NOORDOOSTPOLDERWERKEN)								
BOUWKUNDIGE AFD.	DATUM:	8. 10.'52	BETREFT.					
	GETEK.	<i>Jeursen.</i>	BIJGEBOUWEN					
	GECONTR.	<i>[Signature]</i>	HOOIBERG 450m ³ 200 m ³					
BOERDERJENBOUW	GEZIEN.	<i>[Signature]</i>	SCHAAL.	1:200	ARCH.	FORM.	STAMBOEK No.	Ex.
						A ¹	30965	

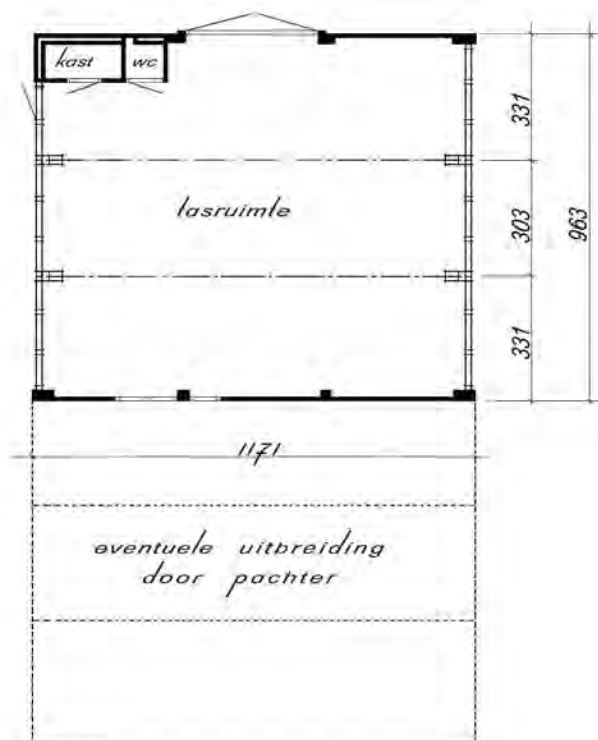
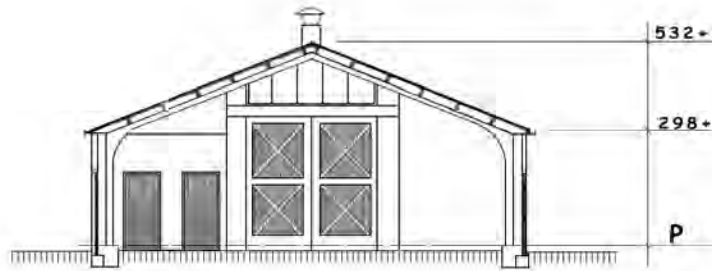

OPP 113 m²
INH 491 m³

DIRECTIE VAN DE WIERINGERMEER (NOORDOOSTPOLDERWERKEN)

BOUWKUNDIGE AFD.	DATUM:	28.10.55	BETREFT.			
	GETEK.	<i>Jeursen.</i>	GROENTE EN FRUITTEELTBEDRIJVEN			
BOERDERIJENBOUW	GECONTR.	<i>[Signature]</i>	BEDRIJFSSCHUUR TYPE n			
	GEZIEN.	<i>[Signature]</i>	ARCH.	FORM.	STAMBOEK No.	Ex.
	SCHAAL.	1:200		A ¹	49 8 26	

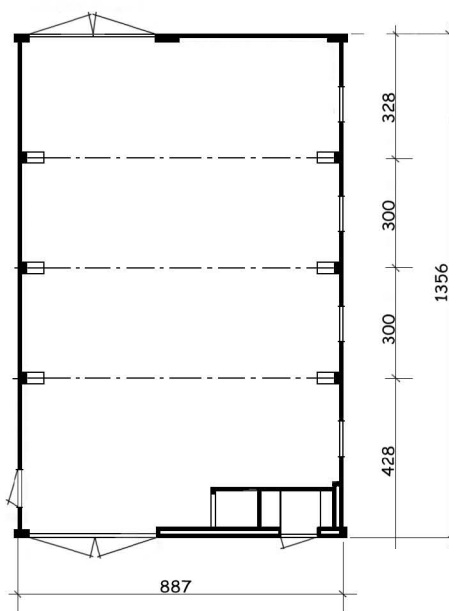
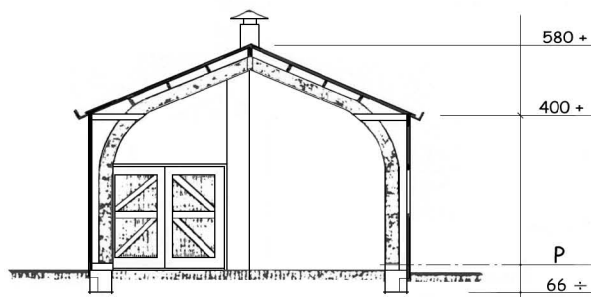

OPP. 120 m²
INH. 615 m³

DIRECTIE VAN DE WIERINGERMEER (NOORDOOSTPOLDERWERKEN)								
BOUWKUNDIGE AFD.	DATUM:	14 -10 -1958	BETREFT. GROENTE EN FRUITTEELDBEDRIJVEN BEDRUFSSCHUUR TYPE P					
	GETEK.	<i>Jeursen.</i>						
	GECONTR.	<i>[Signature]</i>						
BOERDERIJENBOUW	GEZIEN.	<i>[Signature]</i>	SCHAAL.	1:200	ARCH.	FORM.	STAMBOEK No.	Ex.
						A¹	59949	

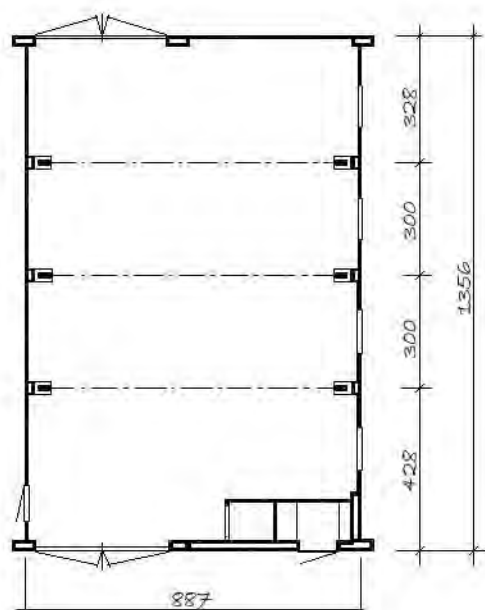
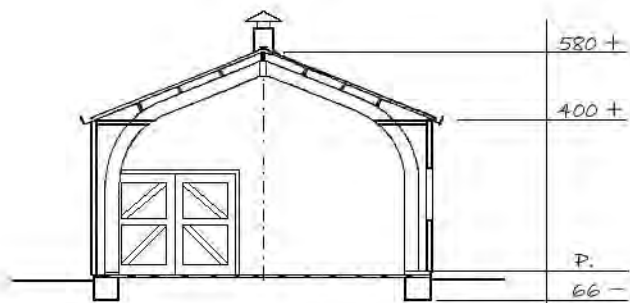

GROENTETEELTBEDRIJF

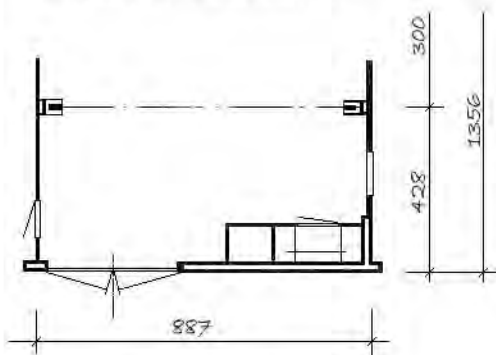

FRUITTEELTBEDRIJF

OPP. 120 m²

INH. 615 m³

DIRECTIE VAN DE WIERINGERMEER (NOORDOOSTPOLDERWERKEN)					
BOUWKUNDIGE AFD.	DATUM:	14 -10 -1958	BETREFT :		
	GETEK:	<i>Jeursen.</i>	GROENTE EN FRUITTEELTBEDRIJVEN		
	GECON:		BEDRIJFSSCHUUR TYPE P		
BOERDERIJENBOUW	GEZIEN:	<i>[Signature]</i>	ARCH.	FORM.	STAMBOEK No.
	SCHAAL. 1 : 200		9 2	4 4	5 5 5 5
					EX.